



Spec. No.: MDGD104-SN05-0
Version: 0.1
Total pages: 20
Date: 2004-March-24

AU OPTRONICS CORPORATION

Product Functional Specifications

10.4" SVGA Color TFT-LCD Module

Model Name: G104SN05

Approved by	Prepared by
<i>Martin Sun</i>	<i>Cynthia Lin</i>

GD- MDBU Marketing Division / AU Optronics Corporation

Customer	Checked & Approved by



Version: 0.1
Total Pages: 20
Date: 2004/03/24

Product Functional Specification
10.4 inch SVGA Color TFT LCD Module
Model Name: G104SN05

Preliminary Specification
 Final Specification

Note: This Specification is subject to change without notice.



Record of Revision

Version	Revise Date	Page	Old Description	New Description	Remark
0	24/March/2004	20	First draft	First draft	



Contents:

A. Physical specifications..... P5

B. Electrical specifications..... P6

 1. Pin assignment..... P6

 2. Absolute maximum ratings..... P7

 3. Electrical characteristics..... P8

 a. Typical operating conditions..... P8

 b. Display color v.s. input data signals..... P9

 c. Input signal timing..... P10

 d. Display position..... P11

 e. Backlight driving conditions..... P12

C. Optical specifications..... P13

D. Reliability test items..... P15

E. Display quality..... P16

F. Handling precaution P16

G. Packing form..... P17

Appendix:

 Fig.1 LCM outline dimensions..... P18

 Fig.2 LCM outline dimensions..... P19

 Fig.3 Timing chart..... P20



A. Physical specifications

NO.	Item	Specification	Remark
1	Display resolution (pixel)	800(H)×600(V)	
2	Active area (mm)	211.2(H)×158.4(V)	
3	Screen size (inch)	10.4(Diagonal)	
4	Pixel pitch (mm)	0.264(H)×0.264(V)	
5	Color configuration	R. G. B. Vertical stripe	
6	Overall dimension (mm)	243.0(W)×184.0(H)×27.2(D) (typ.)	Note 1
7	Weight (g)	530 ±10	

Note 1: Refer to Fig. 1. & 2.



B. Electrical specifications

1. Pin assignment

(1) Input signal interface

	Symbol	Function	Etc.
1	V _{CC}	+3.3 V power supply	
2	V _{CC}	+3.3 V power supply	
3	GND	Ground	
4	GND	Ground	
5	RxIN0-	LVDS receiver signal channel 0	
6	RxIN0+		
7	GND	Ground	
8	RxIN1-	LVDS receiver signal channel 1	
9	RxIN1+		
10	GND	Ground	
11	RxIN2-	LVDS receiver signal channel 2	
12	RxIN2+		
13	GND	Ground	
14	CKIN-	LVDS receiver signal clock	
15	CKIN+		
16	GND	Ground	
17	NC	No Connection	
18	NC	No Connection	
19	GND	Ground	
20	GND	Ground	

CN1 (20P) connector: HRS DF 19K-20P-1H or compatible



(2) LVDS transmitter/receiver signal mapping

	Symbol	Function	
TxIN0	R0	Red data (LSB)	6 bit red display data
TxIN1	R1	Red data	
TxIN2	R2	Red data	
TxIN3	R3	Red data	
TxIN4	R4	Red data	
TxIN5	R5	Red data (MSB)	
TxIN6	G0	Green data (LSB)	6 bit green display data
TxIN7	G1	Green data	
TxIN8	G2	Green data	
TxIN9	G3	Green data	
TxIN10	G4	Green data	
TxIN11	G5	Green data (MSB)	
TxIN12	B0	Blue data (LSB)	6 bits blue display data
TxIN13	B1	Blue data	
TxIN14	B2	Blue data	
TxIN15	B3	Blue data	
TxIN16	B4	Blue data	
TxIN17	B5	Blue data (MSB)	
TxIN18	Hs	Horizontal sync.	
TxIN19	Vs	Vertical sync.	
TxIN20	DE	Data enable	
TxCLKIN	CLK	Clock	Dot clock

2. Absolute maximum ratings

(GND = 0 V)

Parameter	Symbol	Values		Unit	Remark
		Min.	Max.		
Power voltage	V_{CC}	-0.3	4	V_{DC}	At 25°C
Input signal voltage	V_{LH}	-0.3	$V_{CC}+0.3$	V_{DC}	At 25°C
Operating temperature	T_{op}	0	+50	°C	Note 1
Storage temperature	T_{ST}	-20	+60	°C	Note 1

Note 1: The relative humidity must not exceed 90% non-condensing at temperatures of 40°C or less. At temperatures greater than 40°C, the wet bulb temperature must not exceed 39°C. When operate at low temperatures, the brightness of CCFL will drop and the lifetime of CCFL will be reduced.

Note 2: The unit should not be exposed to corrosive chemicals.

3. Electrical characteristics

a. Typical operating conditions

	Item	Symbol	Min.	Typ.	Max.	Unit	Remark
Power supply voltage	Input voltage	V_{CC}	3.0	3.3	3.6	V	
	Current consumption	I_A	243.7	242	245.2	mArms	Note 1
		I_B	255.4	252.1	253.5	mArms	
	Inrush current	I_{RUSH}	-	-	1500	mApeak	Note 2
Internal logic	Low voltage	V_{IL}	0	-	$0.3 V_{CC}$		
	High voltage	V_{IH}	$0.7 V_{CC}$	-	V_{CC}		
	Power ripple voltage	V_{RP}	-	-	100	mVp-p	

Note 1: Effective value (mArms) at $V_{CC} = 3.3 V/25^{\circ}C$.

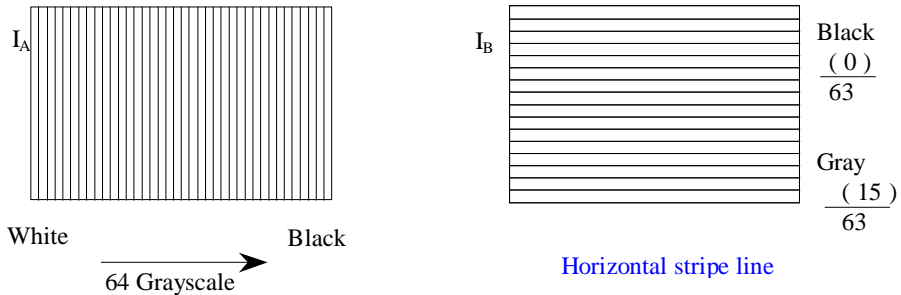

Note 2: Refer to the following power-on condition.

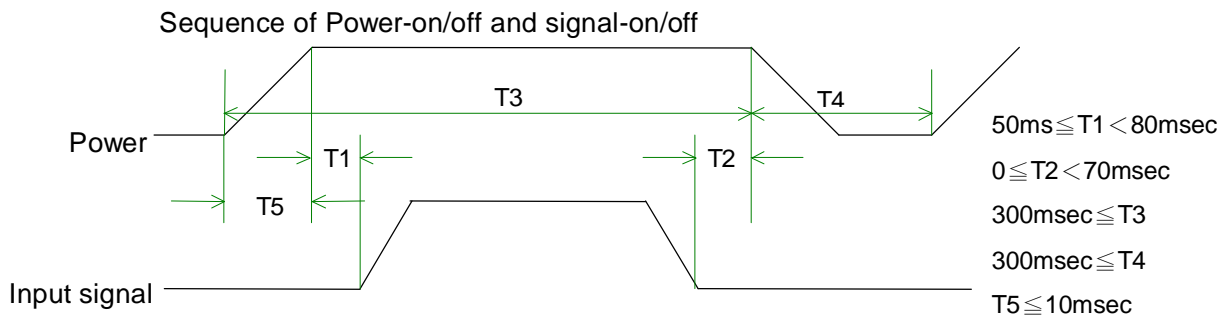
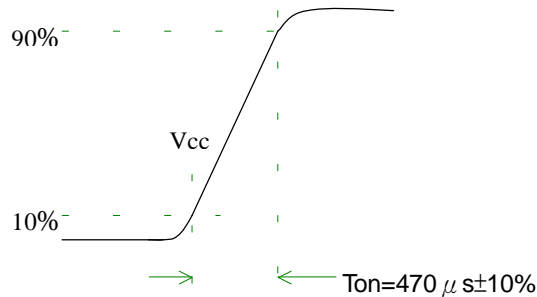

Apply the lamp voltage within the LCD operating range. When the backlight turns on before the LCD operation or the LCD turns off before the backlight turns off, the display may momentarily become abnormal.



Caution

The above on/off sequence should be applied to avoid abnormal function in the display.
 In case of handling:
 Make sure to turn off the power when you plug the cable into the input connector or pull the cable out of the connector.

b. Display color v.s. input data signals

Display colors		Data signal (0: Low level, 1: High level)																	
		R5	R4	R3	R2	R1	R0	G5	G4	G3	G2	G1	G0	B5	B4	B3	B2	B1	B0
Basic colors	Black	0	0	0	0	0	0	0	0	0	0	0	0	0	0	0	0	0	0
	Blue	0	0	0	0	0	0	0	0	0	0	0	0	1	1	1	1	1	1
	Red	1	1	1	1	1	1	0	0	0	0	0	0	0	0	0	0	0	0
	Magenta	1	1	1	1	1	1	0	0	0	0	0	0	1	1	1	1	1	1
	Green	0	0	0	0	0	0	1	1	1	1	1	1	0	0	0	0	0	0
	Cyan	0	0	0	0	0	0	1	1	1	1	1	1	1	1	1	1	1	1
	Yellow	1	1	1	1	1	1	1	1	1	1	1	1	0	0	0	0	0	0
	White	1	1	1	1	1	1	1	1	1	1	1	1	1	1	1	1	1	1
Red grayscale	Black	0	0	0	0	0	0	0	0	0	0	0	0	0	0	0	0	0	0
	Dark	0	0	0	0	0	1	0	0	0	0	0	0	0	0	0	0	0	0
	↑																		
	↓																		
	bright	1	1	1	1	0	1	0	0	0	0	0	0	0	0	0	0	0	0
	Red	1	1	1	1	1	0	0	0	0	0	0	0	0	0	0	0	0	0
Green grayscale	Black	0	0	0	0	0	0	0	0	0	0	0	0	0	0	0	0	0	0
	Dark	0	0	0	0	0	0	0	0	0	1	0	0	0	0	0	0	0	0
	↑																		
	↓																		
	bright	0	0	0	0	0	0	1	1	1	1	0	1	0	0	0	0	0	0
	Green	0	0	0	0	0	0	1	1	1	1	1	1	0	0	0	0	0	0
Blue grayscale	Black	0	0	0	0	0	0	0	0	0	0	0	0	0	0	0	0	0	0
	Dark	0	0	0	0	0	0	0	0	0	0	0	0	0	0	0	0	1	0
	↑																		
	↓																		
	bright	0	0	0	0	0	0	0	0	0	0	0	0	1	1	1	1	0	1
	Blue	0	0	0	0	0	0	0	0	0	0	0	0	1	1	1	1	1	0

Note: Each basic color can be displayed in 64 gray scales using the 6 bit data signals. By combining the 18-bit data signals(R, G, B), the 262,144 colors can be achieved on the display.



c. Input signal timing

Timing diagrams of input signal are shown in Fig 2.

(1) Timing characteristics of input signals

(a) DE mode

Item	Symbol	Min.	Typ.	Max.	Unit	Remark
Clock frequency	Fck	38	40	48	MHz	
Horizontal blanking	Thb1	50	256	500	Clk	
Vertical blanking	Tvb1	10	28	150	Th	

(b) HV mode

Item	Symbol	Min.	Typ.	Max.	Unit	Remark
Clock frequency	Fck	38	40	48	MHz	
Hsync period	Th	850	1056	1300	Clk	
Hsync pulse width	Thw	10	128	-	Clk	
Hsync front porch	Thf	15	40	-	Clk	
Hsync back porch	Thb	10	88	-	Clk	
Hsync blanking	Thb1	50	256	500	Clk	
Vsync period	Tv	610	628	750	Th	
Vsync pulse width	Tvw	1	4	-	Th	
Vsync front porch	Tvf	0	1	-	Th	
Vsync blanking	Tvb1	10	28	150	Th	
Hsync/Vsync phase shift	Tvpd	2	320	-	Clk	

Item	Symbol	Value	Unit	Description
Horizontal display start	The	218	Clk	After falling edge of Hsync, counting 218clk, then getting valid data from 219th clk's data.
Vertical display start	Tve	25	Th	After falling edge of Vsync, counting 25th, then getting 26th Th's data.

(2) The timing condition of LVDS

Item	Symbol	Min.	Typ.	Max.	Unit
The differential level	$ V_{ID} $	0.1	-	0.6	V
The common mode input voltage	VIC	$\frac{ V_{ID} }{2}$	-	$2.4 - \frac{ V_{ID} }{2}$	V
The input setup time	tsu1	500	-	-	ps
The input hold time	th1	500	-	-	ps

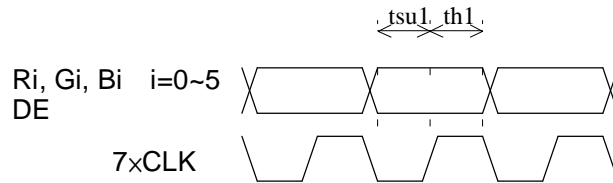
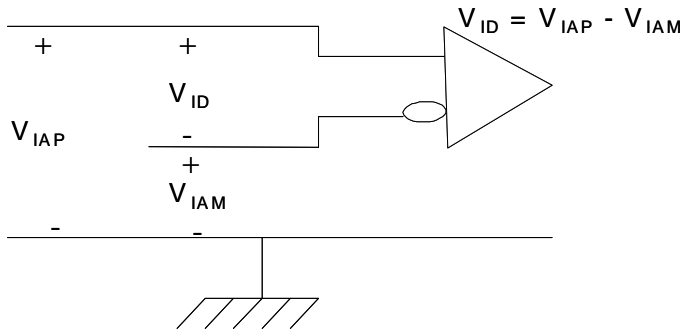

d. Display position

D(1,1)	D(2,1)	D(X,1)	D(799,1)	D(800,1)
D(1,2)	D(2,2)	D(X,2)	D(799,2)	D(800,2)
⋮		⋮	⋮	⋮
D(1,Y)	D(2,Y)	D(X,Y)	D(799,Y)	D(800,Y)
⋮		⋮	⋮	⋮
D(1,599)	D(2,599)	D(X,599)	D(799,599)	D(800,599)
D(1,600)	D(2,600)	D(X,600)	D(799,600)	D(800,600)



e. Backlight driving conditions

Parameter	Symbol	Min.	Typ.	Max.	Unit	Remark
Lamp voltage	V_L	-	420	-	Vrms	Note 1
Lamp current	I_L	33	36	39	mArms	Note 1
Power consumption	P_L	-	15.12	-	W	Note 2
Lamp starting voltage	V_S	-	-	-	Vrms	$T=0^{\circ}\text{C}$
		-	1700	-		$T=25^{\circ}\text{C}$
Frequency	F_L	50	55	60	KHz	Note 3
Lamp life time	L_L	-	50,000	-	Hr	Note 1, 4

Note 1: $T=25^{\circ}\text{C}$, $I_L=6\text{mA/Lamp}$ (Total 6 lamps)

Note 2: Inverter should be designed with the characteristic of lamp. When you are designing the inverter, the output voltage of the inverter should comply with the following conditions.

- (1) The area under the positive and negative cycles of the waveform of the lamp current and lamp voltage should be area symmetric (the symmetric ratio should be larger than 90%).
- (2) There should not be any spikes in the waveform.
- (3) The waveform should be sine wave as possible.
- (4) Lamp current should not exceed the maximum value within the operating Temperature (It is prohibited to over the maximum lamp current even if operated in The non-guaranteed temperature). When lamp current over the maximum value for a long time, it may cause fire. Therefore, it is recommend that the inverter should have the current limited circuit.

Note 3: Lamp frequency may produce interference with horizontal synchronous frequency and this may cause line flow on the display. Therefore lamp frequency shall be detached from the horizontal synchronous frequency and its harmonics as far as possible in order to avoid interference.

Note 4: Brightness ($I_L=6\text{mA/Lamp}$) to be decrease to the 50% of the initial value.

Note 5:

CN2~4 connector (backlight): JST BHR-03VS-1

Pin no.	Symbol	Function	Remark
1	H	CCFL power supply (H.V.)	Cable color: Pink
2	H	CCFL power supply (H.V.)	Cable color: Pink

Mating connector: JST SM03(4.0)B-BHS-1-TB

CN5 connector (backlight): JST BHSR-02VS-1

Pin no.	Symbol	Function	Remark
1	L	CCFL power supply (GND)	Cable color: White
2	L	CCFL power supply (GND)	Cable color: Pink

Mating connector: JST SM02B-BHSS-1-TB

C. Optical specifications (Note 1, Note 2)

Item	Symbol	Condition	Specification			Unit	Remark
			Min.	Typ.	Max.		
Response time							
Rising time	Tr	$\theta = 0^\circ$	-	10	20	ms	Note 4
Falling time	Tf		-	25	30		
Contrast ratio	CR	$\theta = 0^\circ$	400	500	-		Note 3,5
Viewing angle							
Top		$CR \geq 10$	-	40	-	deg.	Note 3,6
Bottom			-	60	-		
Left			-	60	-		
Right			-	60	-		
Brightness	Y_L	$\theta = 0^\circ$	1200	1500	-	nit	Note 3,7,8,9
Color chromaticity(CIE)	Wx	$\theta = 0^\circ$	0.290	0.320	0.350		Note 3,8,9
	Wy		0.300	0.330	0.360		
	Rx		TBD	TBD	TBD		
	Ry		TBD	TBD	TBD		
	Gx		TBD	TBD	TBD		
	Gy		TBD	TBD	TBD		
	Bx		TBD	TBD	TBD		
	By		TBD	TBD	TBD		
White uniformity	δ_w		-	-	1.3		Note 3,9,10

Note 1: Ambient temperature = 25°C.

Note 2: To be measured in dark room after backlight warm up 30 minutes.

Note 3: To be measured with a viewing cone of 1° by Topcon luminance meter BM-5A.

Note 4: Definition of response time:

The output signals of BM-7 are measured when the input signals are changed from “Black” to “White” (falling time) and from “White” to “Black” (rising time), respectively. The response time means the interval between the 10% and 90% of amplitudes. Refer to figure as below.

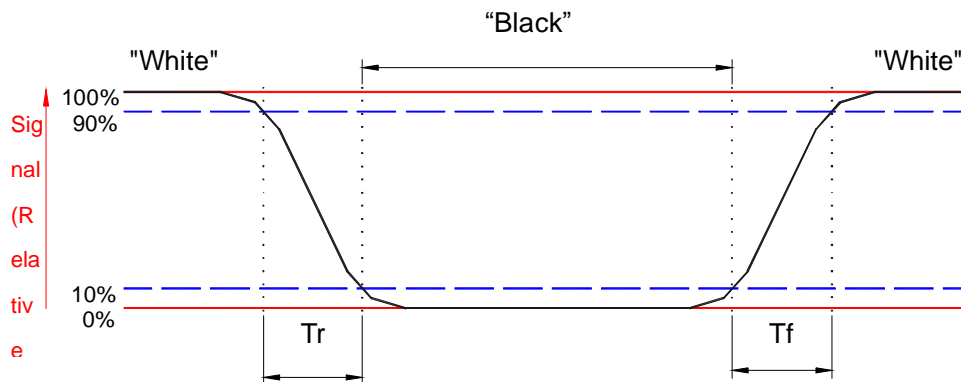

Note 5. Definition of contrast ratio:

Contrast ratio is calculated with the following formula.

$$\text{Contrast ratio (CR)} = \frac{\text{Luminance on the white raster}}{\text{Luminance on the black raster}}$$

Note 6: Definition of viewing angle:

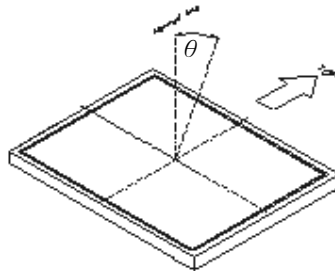

Note 7: Definition of the 5 points (from A to E) on panel, refer to figure as below

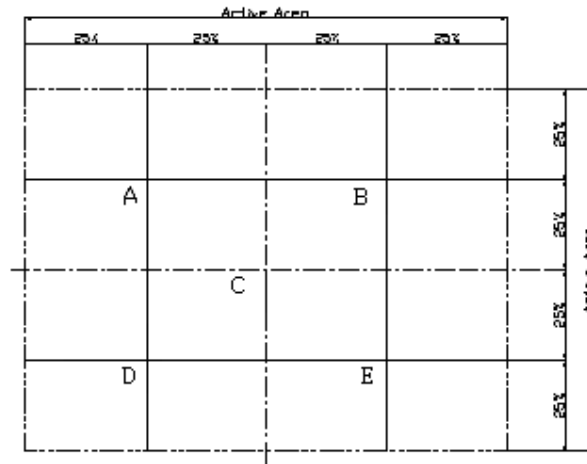

Note 8: Definition of brightness: To measure at center point of the screen (C)
(After light up 20 minutes)

Note 9: Driving conditions for CCFL: $I_L=6$ mA, 55KHz Frequency

Note 10: Definition of white uniformity:

$$\delta w = \frac{\text{Maximum Luminance of five points (brightness)}}{\text{Minimum Luminance of five points (brightness)}}$$



D. Reliability test items (Tentative)

Test tem	Test Condition	Remark
High temperature storage	60°C, 240Hrs	Note 1, 2, 3
Low temperature storage	-20°C, 240Hrs	Note 1, 2, 3
High temperature & high humidity operation	40°C, 90%RH, 240Hrs (No condensation)	Note 1, 2, 3
High temperature operation	50°C, 240Hrs	Note 1, 2, 3
Low temperature operation	0°C, 240Hrs	Note 1, 2, 3
Electrostatic discharge (non-operation)	150 pF, 150 Ω, 10kV, 1 second, 9 position on the panel, 10 times each place	Note 3
Vibration (non-operation)	1.5G, 10Hz ~ 200Hz ~ 10Hz 30 minutes for each Axis (X, Y, Z)	Note 1, 2, 3
Mechanical shock (non-operation)	50G/20ms, ±X, ±Y, ±Z half-Sin, one time	Note 1, 2, 3
Thermal shock (non-operation)	1. -20°C ± 3°C ... 30minutes 60°C ± 3°C ... 30minutes 2. 100 cycles 3. Temperature transition time within 5 minutes	Note 1, 2, 3

Note 1: Evaluation should be tested after storage at room temperature for one hour.

Note 2: There should be no change which might affect the practical display function when the display quality test is conducted under normal operating condition.

Note 3: Judgement: 1. Function OK

2. No serious image quality degradation



E. Display quality

The display quality of the color TFT-LCD module should be in compliance with the AUO's OQC inspection standard.

F. Handling precaution

The Handling of the TFT-LCD should be in compliance with the AUO's handling principle standard.



**G. Packing form:
TBD**

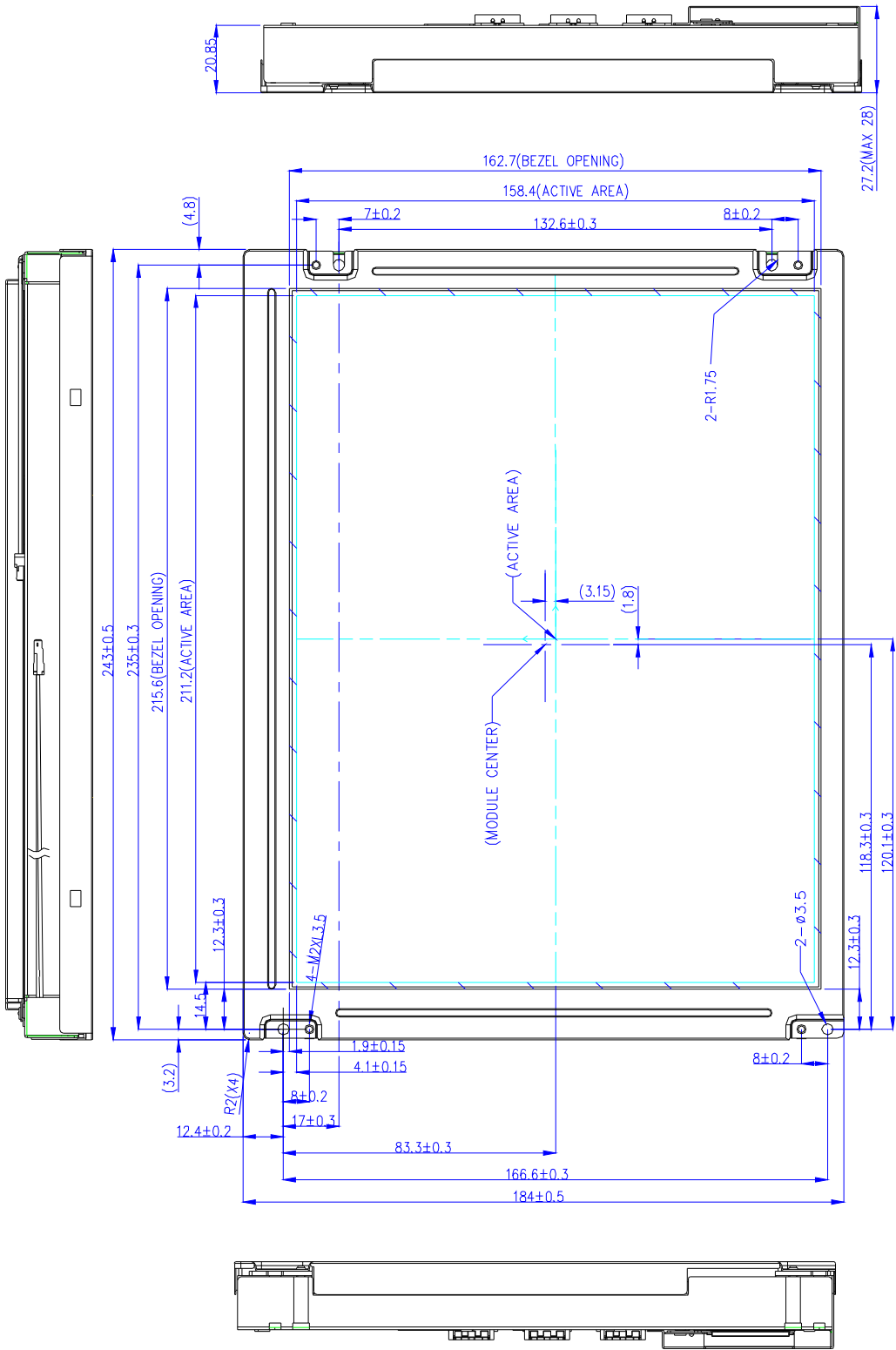

Fig.1 LCM outline dimensions (front side)

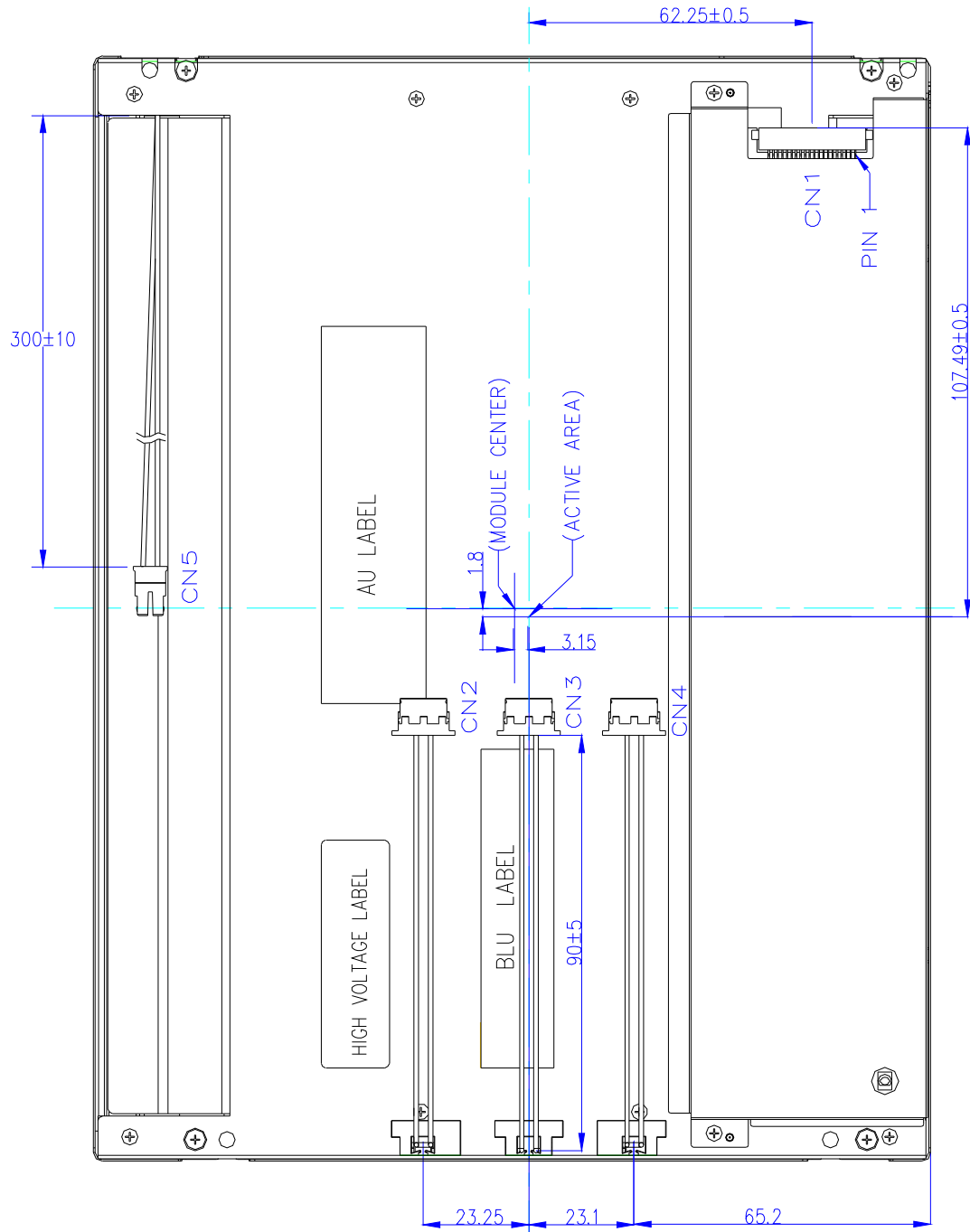

Fig.2 LCM outline dimensions

